



TRUE FOOD SERVICE EQUIPMENT, INC.

2001 East Terra Lane • P.O. Box 970 • O'Fallon, Missouri 63366
 (636)240-2400 • Fax (636)272-2408 • (800)325-6152 • Intl Fax# (001)636-272-7546
 Parts Dept. (800)424-TRUE • Parts Dept. Fax# (636)272-9471 • www.truemfg.com

Project Name: _____

A/A #

Location: _____

Item #: _____ Qty: _____

SIS #

Model #: _____

Model:
T-35

T Series:
Reach-In Solid Door Refrigerator



T-35

- ▶ True's solid door reach-in's are designed with enduring quality that protects your long term investment.
 - ▶ Designed using the highest quality materials and components to provide the user with colder product temperatures, lower utility costs, exceptional food safety and the best value in today's food service marketplace.
 - ▶ Oversized, factory balanced, refrigeration system holds 33°F to 38°F (.5°C to 3.3°C) for the best in food preservation.
 - ▶ 300 series stainless steel solid doors and front. The finest stainless available with higher tensile strength for fewer dents and scratches.
 - ▶ Adjustable, heavy duty PVC coated shelves.
 - ▶ Positive seal self-closing doors. Lifetime guaranteed door hinges and torsion type closure system.
- Bottom mounted units feature:**
- ▶ "No stoop" lower shelf.
 - ▶ Storage on top of cabinet.
 - ▶ Compressor performs in coolest, most grease free area of kitchen.
 - ▶ Easily accessible condenser coil for cleaning.

ROUGH-IN DATA

Specifications subject to change without notice.

Chart dimensions rounded up to the nearest 1/8" (millimeters rounded up to next whole number).

Model	Doors	Capacity (Cu. Ft.) (liters)	Shelves	Cabinet Dimensions (inches) (mm)			HP	Voltage	Amps	NEMA Config.	Cord Length (total ft.) (total m)	Crated Weight (lbs.) (kg)
				L	D	H*						
T-35	2	35 992	6	39 1/2 1004	29 1/2 750	78 3/8 1991	1/3 1/3	115/60/1 230-240/50/1	7.3 2.6	5-15P ▲	9 2.74	340 155

* Height does not include 5" (127 mm) for castors or 6" (153 mm) for optional legs.

▲ Plug type varies by country.



APPROVALS:

AVAILABLE AT:

Model:
T-35

T Series:
Reach-In Solid Door Refrigerator



STANDARD FEATURES

DESIGN

- True's commitment to using the highest quality materials and oversized refrigeration systems provides the user with colder product temperatures, lower utility costs, exceptional food safety and the best value in today's food service marketplace.

REFRIGERATION SYSTEM

- Factory engineered, self-contained, capillary tube system using environmentally friendly (CFC free) 134A refrigerant.
- Extra large evaporator coil balanced with higher horsepower compressor and large condenser; maintains 33°F to 38°F (.5°C to 3.3°C) for the best in food preservation.
- Sealed, cast iron, self-lubricating evaporator fan motor(s) and larger fan blades give True reach-in's a more efficient low velocity, high volume airflow design. This unique design ensures faster temperature recovery and shorter run times in the busiest of foodservice environments.
- Bottom mounted condensing unit positioned for easy maintenance. Compressor runs in coolest and most grease free area of the kitchen. Allows for storage area on top of unit.

CABINET CONSTRUCTION

- Exterior - 300 series stainless steel front. Anodized quality aluminum ends, back and top.
- Interior - attractive, NSF approved, white aluminum liner. 300 series stainless floor with coved corners.

- Insulation - entire cabinet structure and solid doors are foamed-in-place using high density, CFC free, polyurethane insulation.
- Welded, heavy duty galvanized frame rail dipped in rust inhibiting enamel paint for corrosion protection inside and out.
- Frame rail fitted with 4" (102 mm) diameter stem castors - locks provided on front set.

DOORS

- 300 series stainless steel exterior with white aluminum liners to match cabinet interior. Doors extend full width of cabinet shell. Door locks standard.
- Lifetime guaranteed recessed door handles. Each door fitted with 12" (305 mm) long recessed handle that is foamed-in-place with a sheet metal interlock to ensure permanent attachment.
- Positive seal self-closing doors. Lifetime guaranteed door hinges and torsion type closure system.
- Magnetic door gaskets of one piece construction, removable without tools for ease of cleaning.

SHELVING

- Six (6) adjustable, heavy duty PVC coated wire shelves 17¹/₂" L x 22³/₈" D (445 mm x 569 mm). Four (4) chrome plated shelf clips included per shelf.
- Shelf support pilasters made of same material as cabinet interior; shelves are adjustable on 1/2" (13 mm) increments.

LIGHTING

- Incandescent interior lighting - safety shielded. Lights activated by rocker switch mounted above doors.

MODEL FEATURES

- Exterior temperature display.
- Evaporator is epoxy coated to eliminate the potential of corrosion.
- NSF-7 compliant for open food product.

ELECTRICAL

- Unit completely pre-wired at factory and ready for final connection to a 115/60/1 phase - 15 amp dedicated outlet. Cord and plug set included.



115/60/1
NEMA-5-15R

OPTIONAL FEATURES/ACCESSORIES

Upcharge and lead times may apply.

- 230 - 240V / 50 Hz.
- 6" (153 mm) standard legs.
- 6" (153 mm) seismic/flanged legs.
- Additional shelves.
- Half door bun tray racks. Each holds up to eleven 12" L x 20" D (305 mm x 508 mm) sheet pans (sold separately).
- Full door bun tray racks. Each holds up to twenty-two 12" L x 20" D (305 mm x 508 mm) sheet pans (sold separately).
- Remote cabinets (condensing unit supplied by others; system comes standard with 404A expansion valve and requires R404A refrigerant). Consult factory technical service dept. for BTU information.

PLAN VIEW

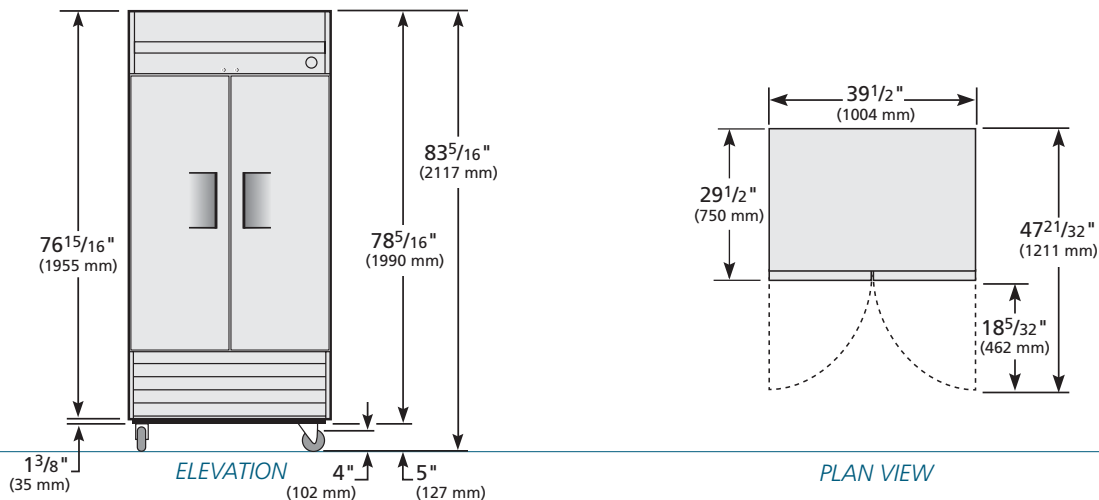

WARRANTY

One year warranty on all parts & labor and an additional 4 year warranty on compressor. (U.S.A. only)

METRIC DIMENSIONS ROUNDED UP TO THE NEAREST WHOLE MILLIMETER
SPECIFICATIONS SUBJECT TO CHANGE WITHOUT NOTICE



Model	Elevation	Right	Plan	3D
T-35	TFEY18E	TFEY04S	TFEY04P	TFEY183

TRUE FOOD SERVICE EQUIPMENT

2001 East Terra Lane • P.O. Box 970 • O'Fallon, Missouri 63366 • (636)240-2400 • Fax (636)272-2408 • (800)325-6152 • Intl. Fax# (001)636-272-7546 • www.truemfg.com